

**DANCOVER<sup>®</sup>**



Manual  
for  
Storage Tent PRO  
3,5 Series PVC/PE

# DANCOVER<sup>®</sup>

.com

## Safety Advice

### Attention

In some countries approval is needed to set up a marquee/tent larger than 75 m<sup>2</sup>. It is your responsibility to comply with local rules and regulations and to ensure that the marquee/tent is assembled correctly.

In case of bad weather conditions, it is your responsibility to ensure the marquee/tent is safely secured and that the marquee/tent does not cause damage to others.

Do not use open fire, welding equipment or other sources which can ignite, inside or close to the tent.

The marquee/tent must be safely secured. We recommend you secure your marquee/tent with straps and pegs as soon as it is assembled.

Make sure to check if the marquee/tent is covered by your home contents insurance.

Marquees/tents must be evacuated under extreme weather conditions.

In the event of snow, always remove snow from the roof of the marquee/tent regularly to prevent snow from building on the roof, as heavy snow can cause the marquee/tent to collapse.

In the event of rain, there is a risk of rain puddles building up on top of the roof of the marquee/tent. Heavy rain puddles can cause the roof to collapse. It is your responsibility to ensure rain puddles do not build up. As a precaution, make sure the roof of the marquee/tent is stretched out properly and adequately over the side frames of the marquee/tent and remove rain water regularly.

Do not unpack or repack your marquee/tent in freezing temperatures. In case of temperatures below zero, always unpack and repack your marquee/tent indoors to avoid the risk of cracking parts.

The marquee/tent must be totally dry before you repack and store it to avoid mildew.

**Note:** Marquees are intended for events and other arrangements and are as such only meant for short term temporary assembly and the following disassembly. Dancover warranty applies only to the normal use of the Product, normal wear and tear excepted, in accordance with written use instructions or manual. The warranty does not apply to damage caused by accident, abuse, misuse, or modification of the Product.

### Warranty Information

Please visit [dancovershop.com](http://dancovershop.com) for information on warranty.

*Please always check our website for the latest safety advice and manual.*

# DANCOVER<sup>®</sup>







.com



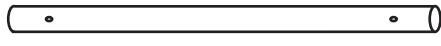
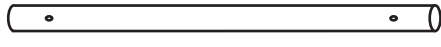
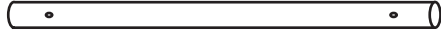
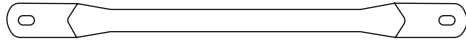
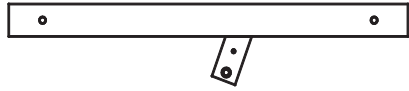
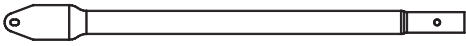
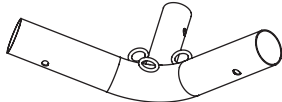
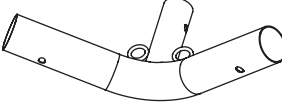
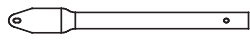
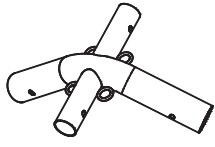
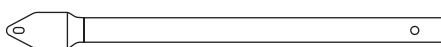
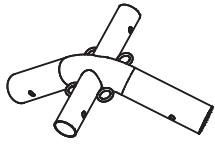
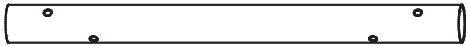
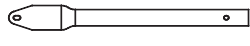

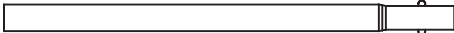
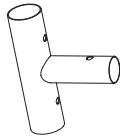
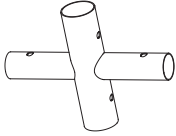
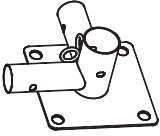
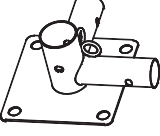
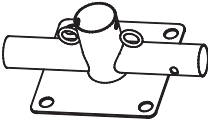
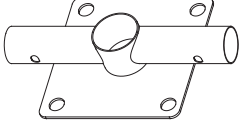

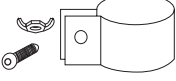
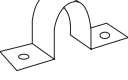

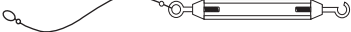
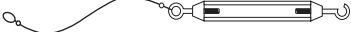

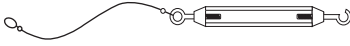

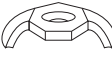

## Warning



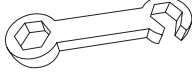

1. In order to avoid being rusted by air, oil is covered on the surface of the pipes. Before setting up the tent, please remove the oil carefully first to keep the cover clean.
2. Take note that the tent needs to be handled carefully to avoid damage.
3. Do not force the frames as they may be damage in the process.
4. Tents are meant as temporary shelter, and must be evacuated under extreme weather conditions.

Please, select a suitable site for the tent to avoid the damage of underground sprinkler systems, water, gas or electrical lines.

Part no.			3.5x8m	3.5x10m
1	Frame pole 1600mm 50-50		18	24
2	Frame pole 1880mm 38-38		30	37
3	Groundbar 1380mm 38-38		2	2
4	Roof support 1730mm 25-25		5	6
5	Frame pole 1600mm 50-50		4	4
6	Diagonal support 1720mm 32-32		8	8
7	3-way connector 54-42/3 rings		4	4
8	3-way connector 54-42/2 rings		2	2
9	Diagonal support 800mm 32-32		4	4
9-1	4-way connector 54-42/4 rings		3	4
10	Female doorbar 1835mm 32-32		2	2
10-1	4-way connector 54-42/4 rings		6	8
11	Lower leg 1600mm 50-50		8	8
12	Female doorbar 970mm 32-32		2	2

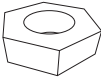
Part no.			3.5x8m	3.5x10m
13	Strengthen bar 1845mm 32-32		2	2
14	3-way connector 54-42		4	4
15	4-way connector 54-42		6	8
16	3-way connector for corner		2	2
17	3-way connector for corner		2	2
18	3-way connector for sidewall		6	8
19	2-way connector for endwall		2	2
20	Strengthen bar 980mm 32-32		2	2
21	Bracket		10	12
22	Groundbracket		8	10
23	Strengthen bar 1855mm 25-25		16	20
24	Turnbuckle for door 4610mm		4	4
25	Turnbuckle for roof 2550mm		16	20

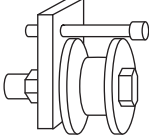
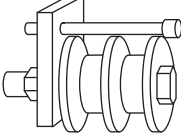
Part no.			3.5x8m	3.5x10m
26	Turnbuckle for side 3700mm		16	20
27	Peg 10x350mm		16	20
28	Spiral peg		4	4
29	Small peg		38	42
30	Bungeeball long		56	56
31	M6 wingnut		22	24
32	Screw M6x30mm		10	12
33	Screw M6x45mm		10	10
34	Screw M6x65mm		2	2
35	M6 nut		4	4
36	Spanner		2	2
37	Tie down		4	4
38	Steel clip		34	40
39	Screw M8x50mm		64	78
40	Screw M8x65mm		68	80
41	M8 nut		132	158
42	Peg 16x600mm		16	18

Part no.			3.5x8m	3.5x10m
43	M12 washer		4	4
44	M12 nut		4	4
45	Screw M12x48mm		2	2
46	Screw M12x65mm		2	2
47	Sheaved block 1 wheel		2	2
48	Sheaved block 2 wheel		2	2
49	Ratchet stape		4	4
50	Roof		1	1
51	Endwall		2	2

3.5x8-10x3.3m storage pro	Part 31		Part 32		Part 33	Part 34	Part 35	Part 39		Part 40		Part 41		Part 43	Part 44	Part 45	Part 46
	M6 Wing nut		M6x30 Screw		M6x45 Screw	M6x65 Screw	M6 Nut	M8x50 Screw (Ø42)		M8x65 Screw (Ø54)		M8 Nut		M12 Washer	M12 Nut	M12x48 Screw	M12x65 Screw
	3.5x8	3.5x10	3.5x8	3.5x10	3.5x8			3.5x8	3.5x10	3.5x8	3.5x10	3.5x8	3.5x10				
Used for Part 4 and Part 21			10	12													
Used for Part 6 and Part 12					2												
Used for Part 6 and Part 10					2												
Used for Part 6 and Part 9					4												
Used for Sheaved block 1wheel Part 47					2		2									2	
Used for Sheaved block 2 wheel Part 48						2	2										2
Used for M6x30	10	12															
Used for M6x45	10	10															
Used for M6x65	2	2															
Used for 2-way connector 19								4	4								
Used for 3-way connector 7								4	4	8	8						
Used for 3-way connector 8								2	2	4	4						
Used for 3-way connector 14								4	4	8	8						
Used for 3-way connector 16								4	4	2	2						
Used for 3-way connector 17								4	4	2	2						
Used for 3-way connector 18								12	16	6	8						
Used for 4-way connector 9-1								6	8	6	8						
Used for 4-way connector 10-1								12	16	12	16						
Used for 4-way connector 15								12	16	12	16						
Used for Part 6 and Part 11										4	4						
Used for Part 9 and Part 11										4	4						
Used for M8x50												64	78				
Used for M8x65												68	80				
Used for M12x48														2	2		
Used for M12x65														2	2		
	22	24	10	12	10	2	4	64	78	68	80	132	158	4	4	2	2



# I

Select a flat surface at ground for the tent, unpack the carton and check all the parts including tubes, tent and accessories... etc. are present and the same as the list.

Assemble the framework of rooftop by joining the portion (7, 8, 9-1, 10-1) together with poles (1, 2, 4, 5, 6, 12) NO. 11 is on four corners for diagonal pipe.

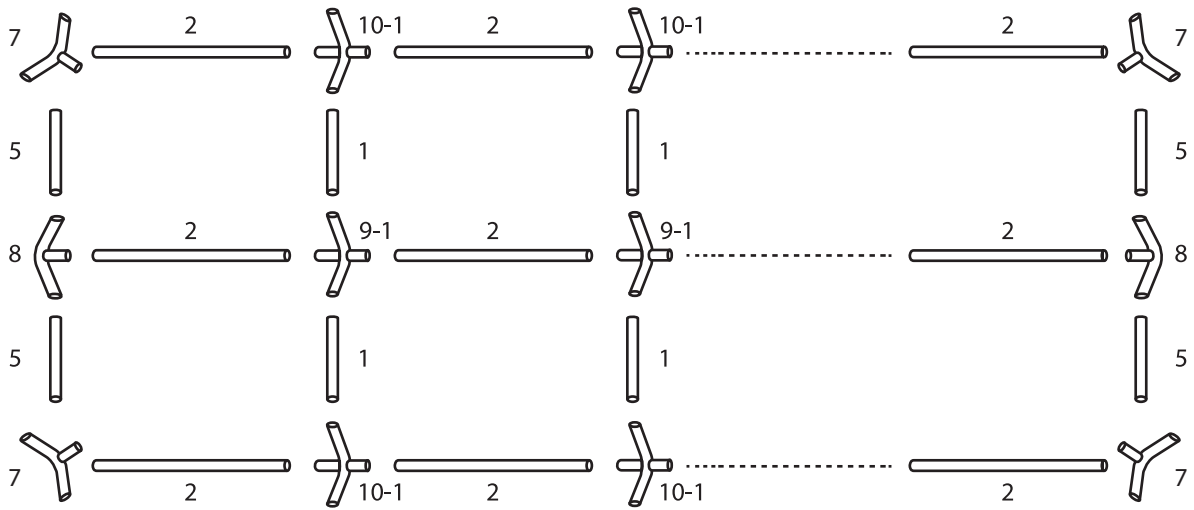

# II

To ensure the screw fixed to every pole tightly. And then use the turnbuckle set which is diagonally across through each section as below.

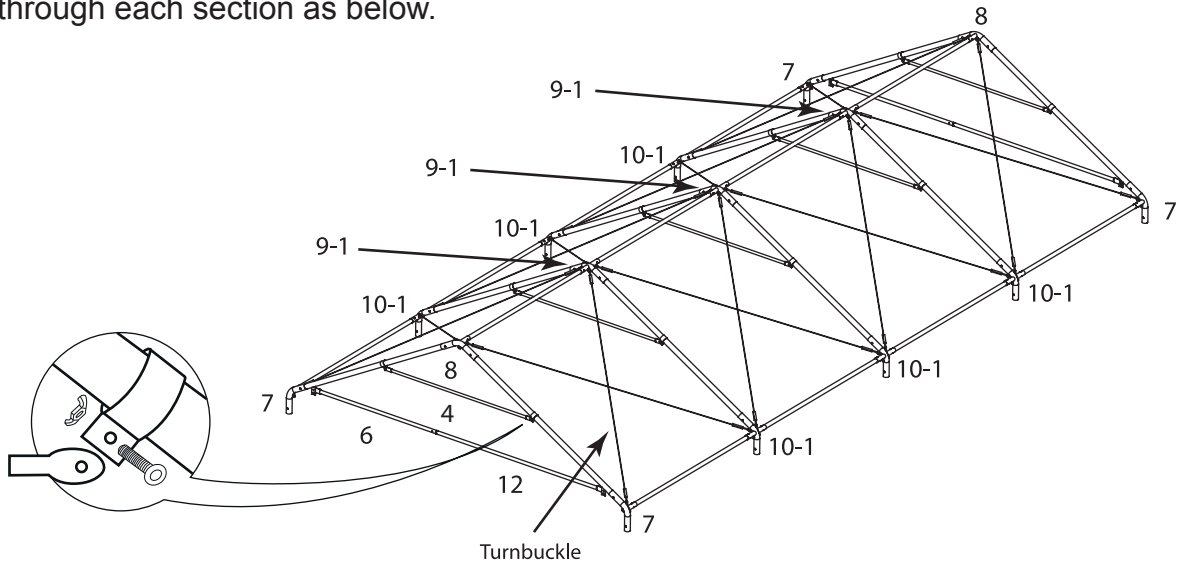

# III

Attach one end of supported pole (1) to the joints.

If you want the rope pull at the opposite side than shown in the drawing then switch sheaved block (47) and (48)

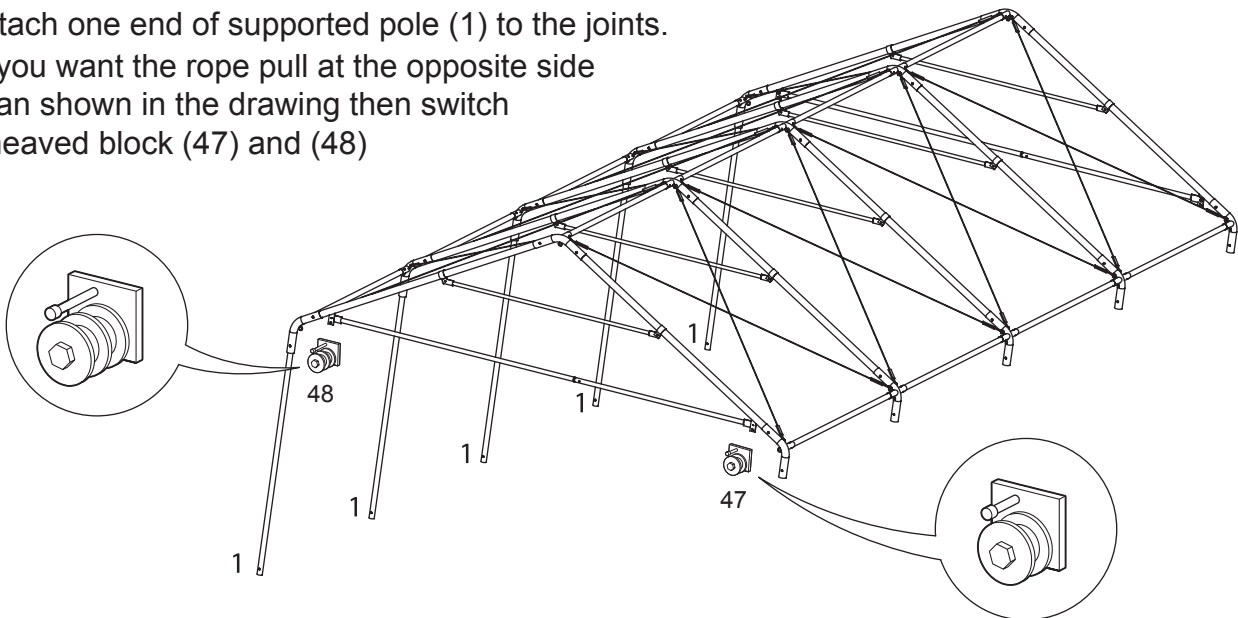

# IV

Attach the other supported poles (1, 2, 11) to the joints, built-up the framework. NO. 11 is on four corners for diagonal pipe.

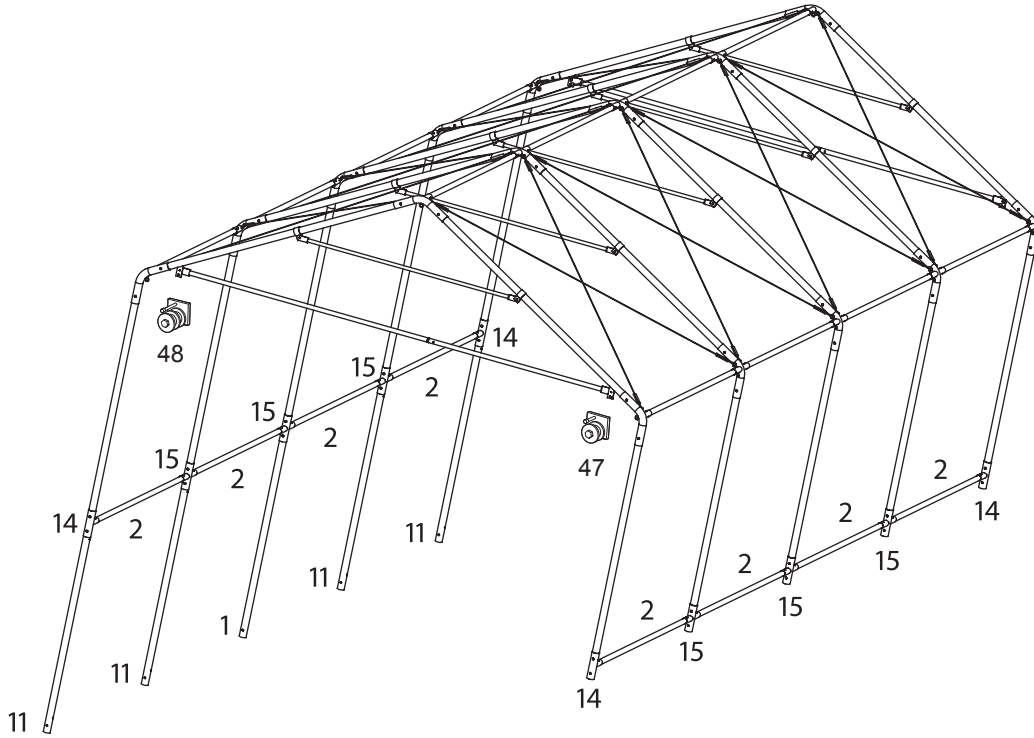

# V

You facilitate the assembly and dismantling by pulling the roof with ropes on tent frame. Use the steel clips to fasten the cover to the frame. Each section we offer bracket and nail to fasten the frame to ground.

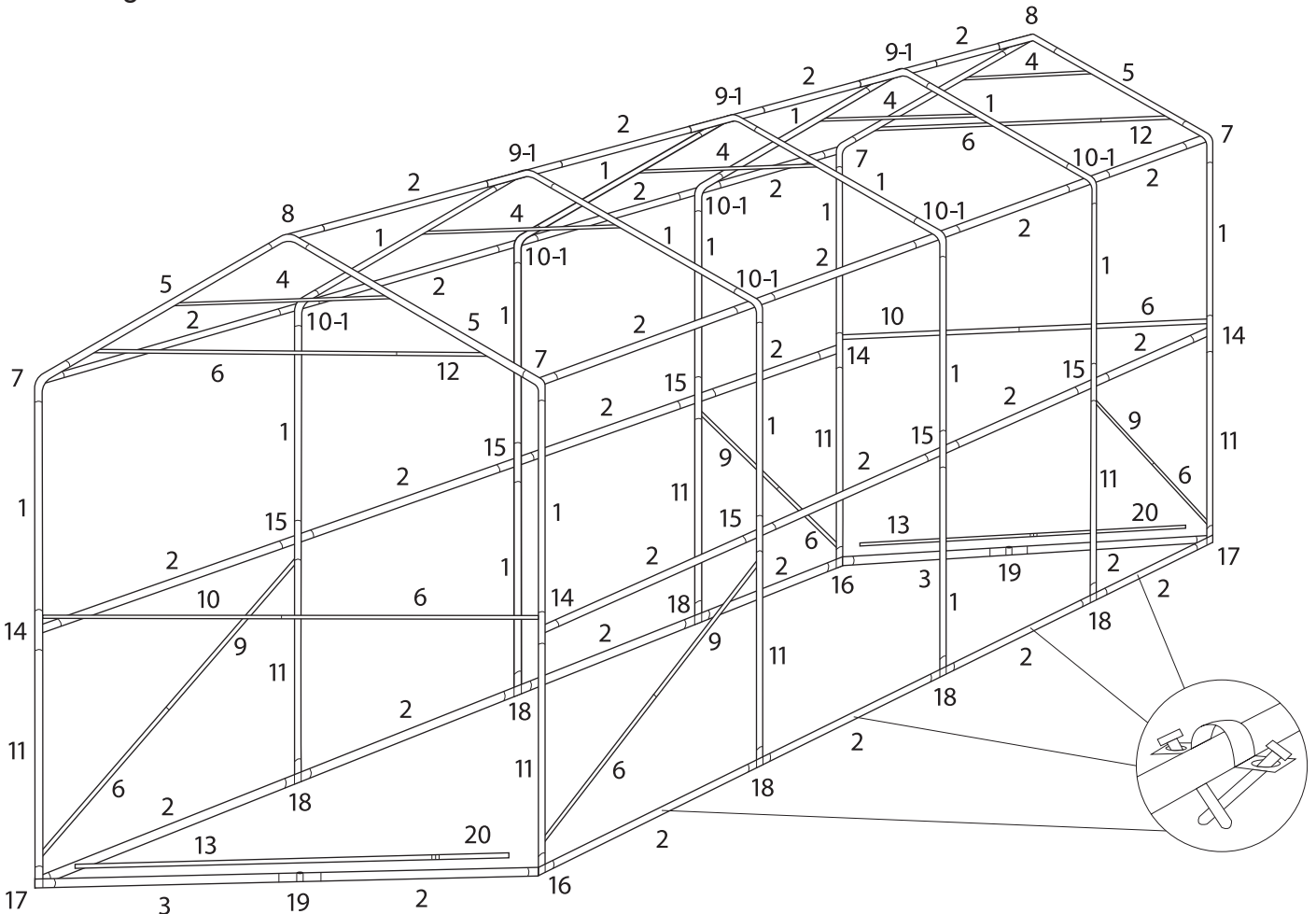

# VI

Spread the wall panel and door panel attach to framework by using the bungee cords clasp the frame to grommets that is construct over the wall panel and door panel to ensure stability. Also use the short pegs to fix the doors to the ground.

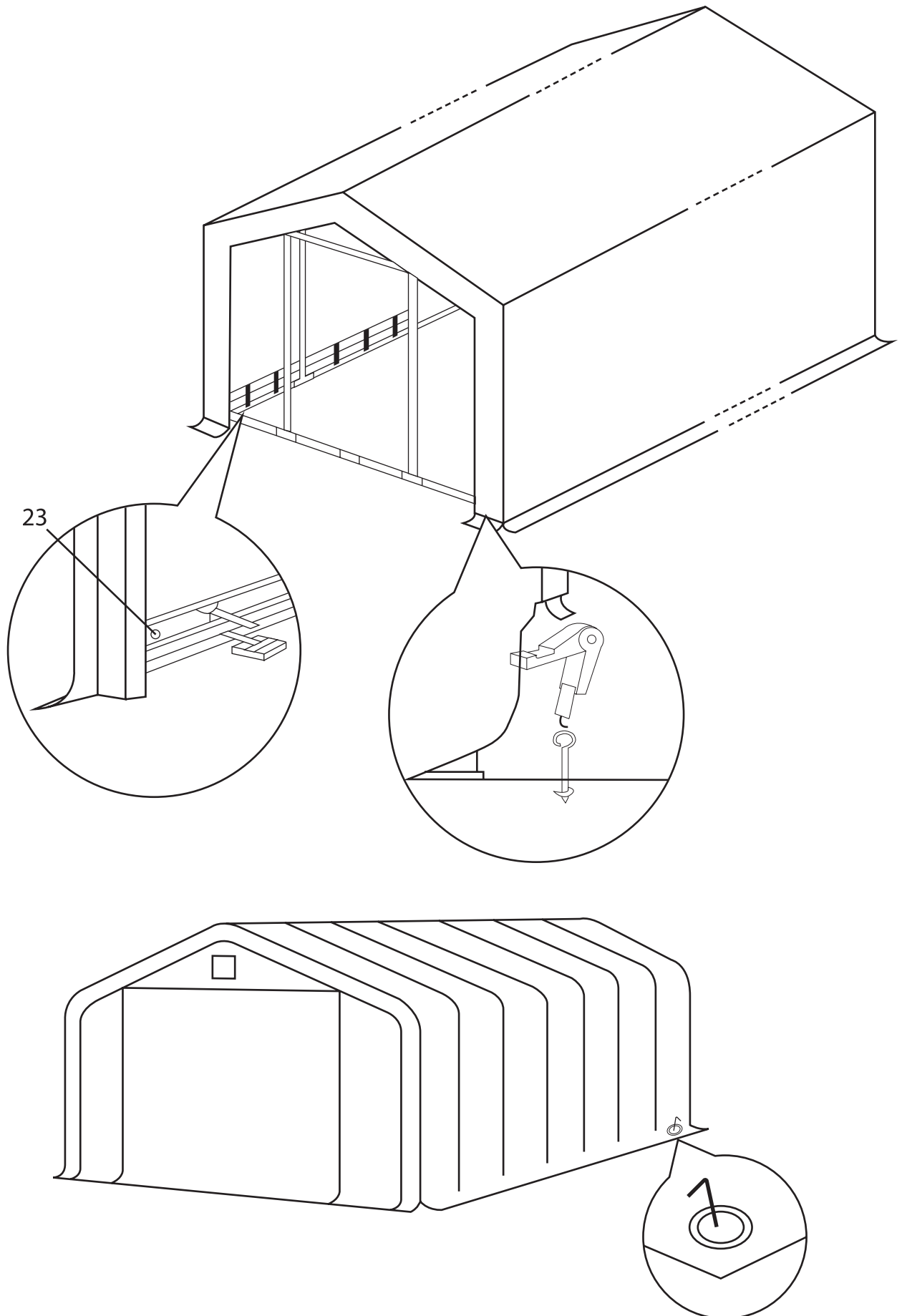

## Contact information

### Head office:

Dancover A/S  
Nordre Strandvej 119 G  
3150 Hellebæk  
Denmark

For more information  
please visit:  
[www.dancovershop.com](http://www.dancovershop.com)

## National contact

Denmark: 70 26 76 20  
[denmark@dancover.com](mailto:denmark@dancover.com)

UK: 020 8099 7570  
[uk@dancover.com](mailto:uk@dancover.com)

Germany: 041 0266 7040  
[germany@dancover.com](mailto:germany@dancover.com)

France: 0975 181 800  
[france@dancover.com](mailto:france@dancover.com)

Sweden: 040 233 262  
[sverige@dancover.com](mailto:sverige@dancover.com)

Finland: 0 931 581 720  
[suomi@dancover.com](mailto:suomi@dancover.com)

Poland: 22 300 8602  
[polska@dancover.com](mailto:polska@dancover.com)

Luxembourg: +49 041 0266 7040  
[luxembourg@dancover.com](mailto:luxembourg@dancover.com)

Portugal: 308 800 899  
[portugal@dancover.com](mailto:portugal@dancover.com)

Spain: 911 436 828  
[espana@dancover.com](mailto:espana@dancover.com)

Italy: 02 479 21 198  
[italia@dancover.com](mailto:italia@dancover.com)

Switzerland: 0840 000125  
[schweiz@dancover.com](mailto:schweiz@dancover.com)

Austria: 0662 626935  
[austria@dancover.com](mailto:austria@dancover.com)

Norway: 231 00 690  
[norge@dancover.com](mailto:norge@dancover.com)

Nederland: 0 858 880 524  
[nederland@dancover.com](mailto:nederland@dancover.com)

Ireland: 0 151 33 003  
[ireland@dancover.com](mailto:ireland@dancover.com)

Belgium: 0 28 08 08 09  
[belgique@dancover.com](mailto:belgique@dancover.com)